



Product Code

VP32488



32A 2P+E Angled Wall Socket IP44

★ Rated current:32A
★ Rated voltage: 220-250V
★ No. of poles:2P+E
★ Protection degree: IP44
★ Housing material: Flame Retardant PA6 RoHS Reach Contact: nickel-plated brass RoHS Reach
★ Standards: IEC60309-1, IEC60309-2
★ Certificates: S,CB,CE,TUV,ISO9001:2008,RoHS,REACH

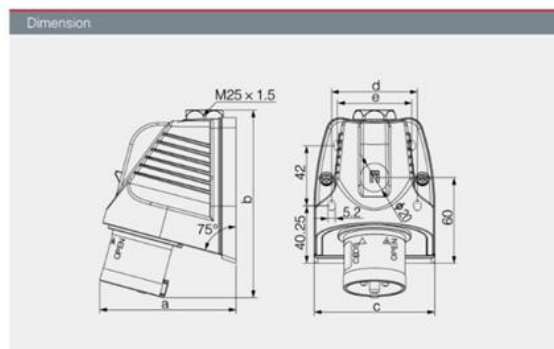

Current	16A			32A		
Pole	3	4	5	3	4	5
a	117	117	118.5	120	120	119
b	142	142.5	114.5	156	156	158
c	84.4	84.4	84.4	84.4	84.4	84.4
d	60	60	60	60	60	60
e	52	52	52	52	52	52
Cable size(mm ²)	1.5-4			2.5-10		

